

SOFT COLOUR INTERACTIONS AND PARTON RESCATTERING IN QCD

(or: Gaps — in my understanding after 20 years)

Gunnar Ingelman (Uppsala University)

People involved:

- Johan Rathsman
- Anders Edin
- Nicusor Tîmneanu
- Rikard Enberg
- Cristiano Brenner Mariotto
- David Eriksson
- Korinna Zapp
- Stan Brodsky
- Paul Hoyer

- Introduction/history
- Soft Colour Interaction model
 - ↪ soft gaps in ep and $p\bar{p}$
 - ↪ charmonium production
 - ↪ B decays
 - ↪ jet quenching in QGP
- Parton rescattering in QCD
 - ↪ theoretical basis
 - ↪ model developments
- Conclusions & Outlook

Rapidity gap events given by final state topology

$$\text{Rapidity} = y = \frac{1}{2} \ln \frac{E+p_z}{E-p_z} \approx -\ln \tan \frac{\theta}{2} = \eta = \text{pseudorapidity}$$

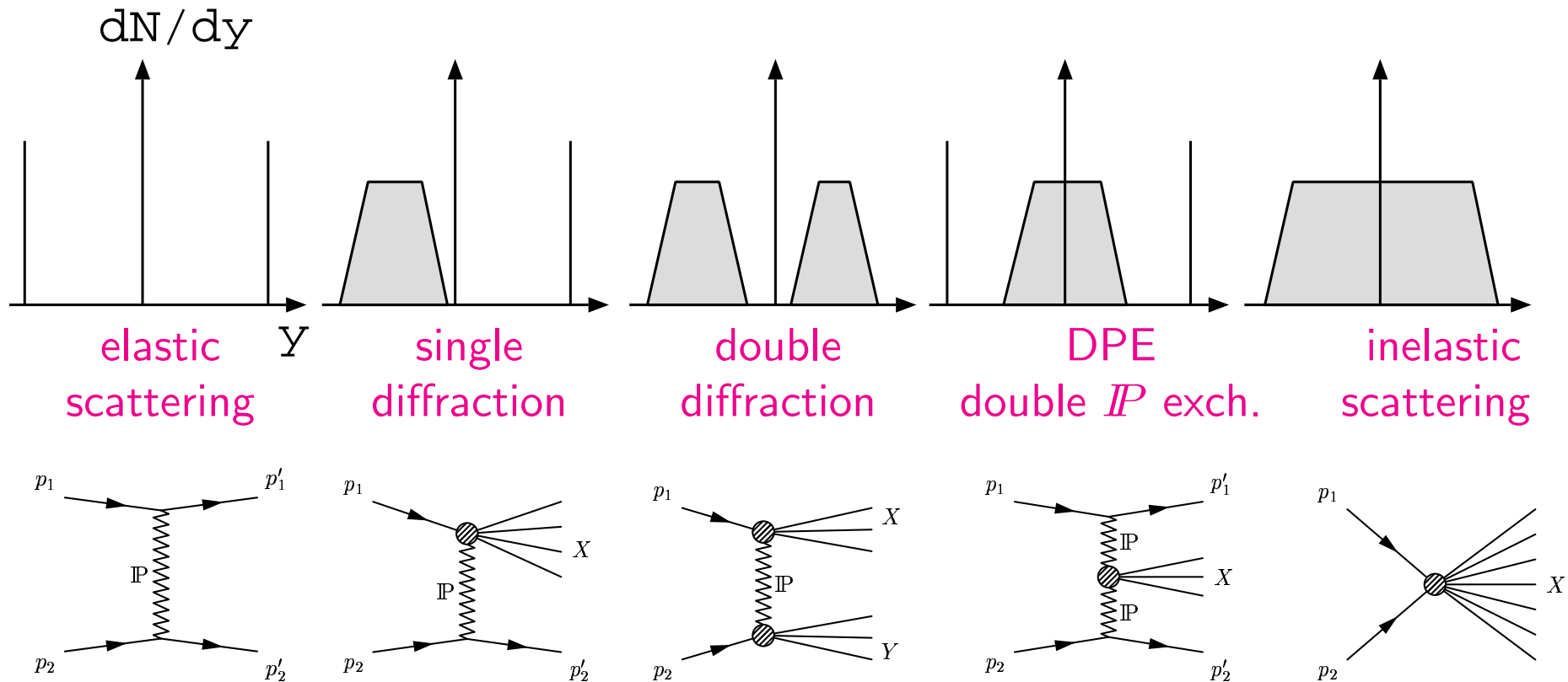

Pomeron exchange in Regge theory/phenomenology

Diffractive hard scattering

Idea: Ingelman-Schlein, Phys. Lett. 1985

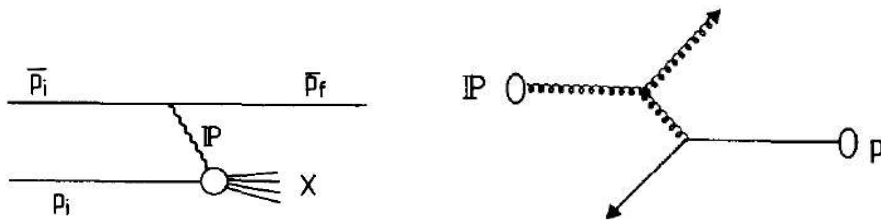

- hard scale probes parton level
- IP flux
- IP structure function

Predicted:

- jets etc. in single diffraction
- diffractive deep inelastic scattering

Discovery: UA8 at $Spp\bar{S}$ 1988

- jets in single diffraction \simeq model
- hard gluons $xg(x) \sim x(1-x)$ in IP
- 'superhard' $\delta(1-x)$ component

More exp's: HERA ep , Tevatron $p\bar{p}$

Diffractive DIS – HERA discovery

GI+Prytz 1993:

$$\frac{d\sigma}{dx dQ^2 dx_{IP} dt} =$$

$$\frac{2\pi\alpha^2}{xQ^4} (1 + (1-y)^2) F_2^{D(4)}$$

$$F_2^{D(4)}(x, Q^2, x_{IP}, t) =$$

$$\underbrace{f(x_{IP}, t)}_{IP \text{ flux}} \underbrace{F_2^{IP}(\beta, Q^2)}_{IP \text{ structure}}$$

Fits HERA rapidity gap data

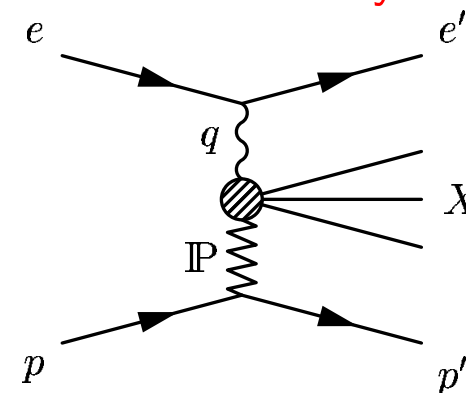

Pomeron problems:

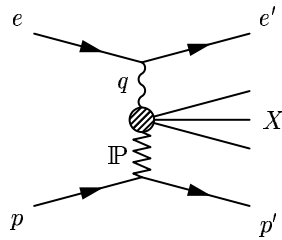

- IP model fitted to HERA data
→ fails for Tevatron data
 $\sigma(\text{hard diff})$ factor 6–100 too large
→ need ‘damping’ at high energies,
e.g. IP flux ‘renormalisation’
- IP flux & structure not universal
ill-defined for virtual IP
- Factorisation broken in diffractive $p\bar{p}$
– coherent interactions
- Improper with IP ‘emitted’ from p
soft, long space-time-scale interaction
→ IP - p cross-talk

Soft Colour Interactions:

- hard pQCD left unchanged
– not affect by soft interactions
- non-pQCD below $Q_0^2 \sim 1 \text{ GeV}^2$
- α_s large \Rightarrow large interaction probability
e.g. unity for hadronisation!
- no proper theory → models
- colour exchange modifies colour/string topology → different final state
- single model describing all final states
– diffractive \leftrightarrow nondiffractive

Soft Colour Interaction model (SCI)

Soft interactions among partons & remnants (\leftrightarrow proton colour field) below $Q_0^2 \sim 1 \text{ GeV}^2$

Add-on to Lund Monte Carlo's LEPTO (ep) and PYTHIA ($p\bar{p}$)

ME + DGLAP PS $> Q_0^2$ \rightarrow SCI model \rightarrow String hadronisation $\sim \Lambda$
 colour ordered parton state \rightarrow rearranged colour order \rightarrow modified final state

Single model describing all final states: diffractive \leftrightarrow nondiffractive

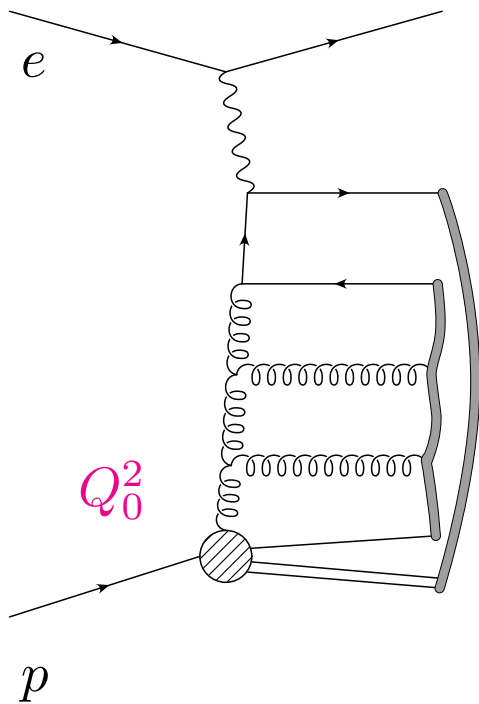

Single parameter $P = \text{const} \approx 0.5$
 gives probability for soft ($p \simeq 0$)
 colour-anticolour (gluon) exchange
 between parton pairs,
 determined from HERA rap-gap data

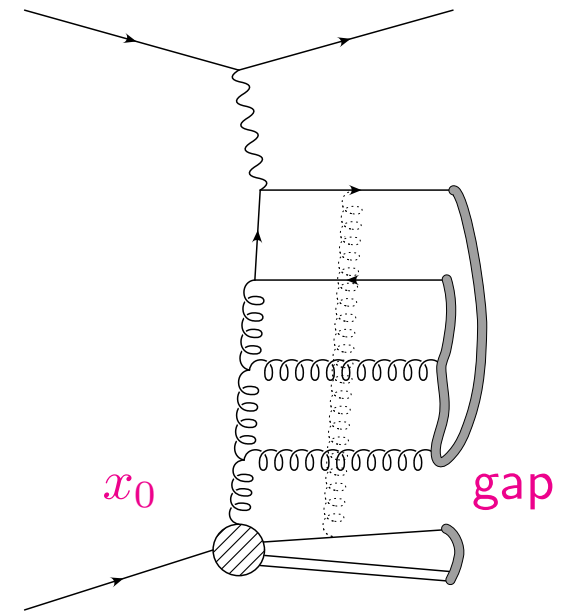

Proton remnant with $(1 - x_0)$ important for large gaps

Gap-size is infrared sensitive observable !

Size Δy_{max} of largest gap in DIS events

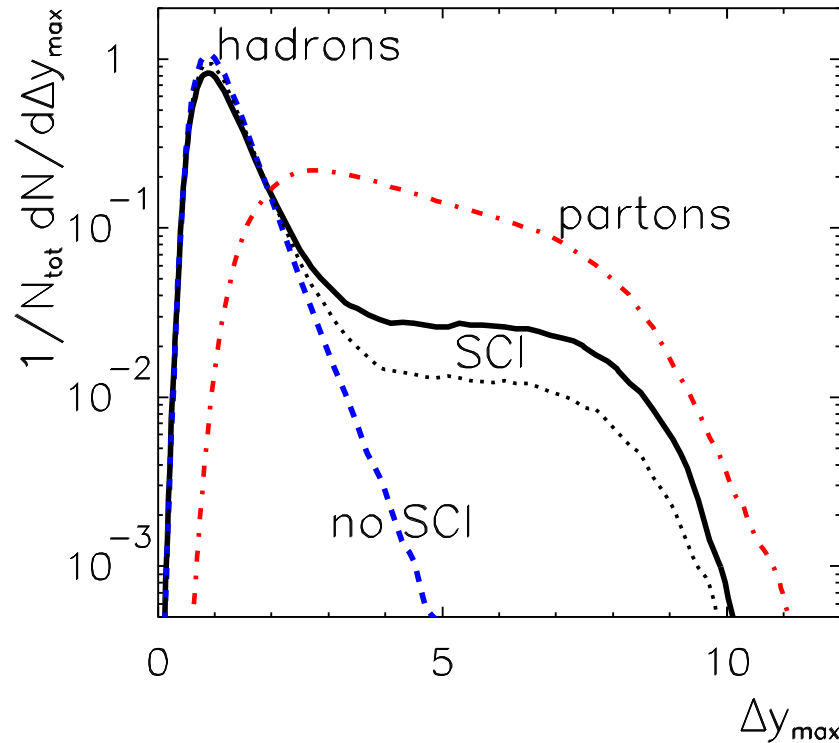

SCI \Rightarrow plateau in Δy_{max}
characteristic for diffraction

Small parameter sensitivity

— $P = 0.5$

... $P = 0.1$

Large gaps at parton level
normally string across \rightarrow hadrons fill up
SCI \rightarrow new string topologies, some with gaps

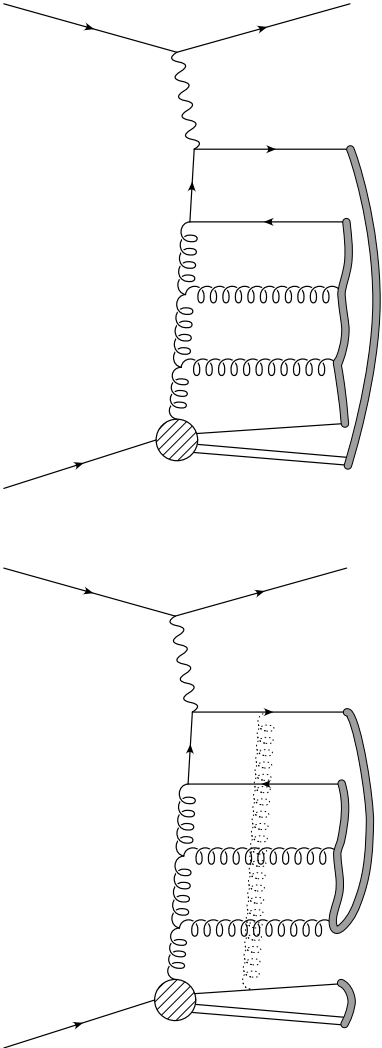

Diffractive structure function in DIS

$$x_{\mathcal{I}P} F_2^{D(3)}(Q^2, \beta, x_{\mathcal{I}P})$$

SCI model describes
main features of HERA
rapidity gap data

Not bad for a
one-parameter model !

GAL is an alternative
formulation of the model,
based on string interactions

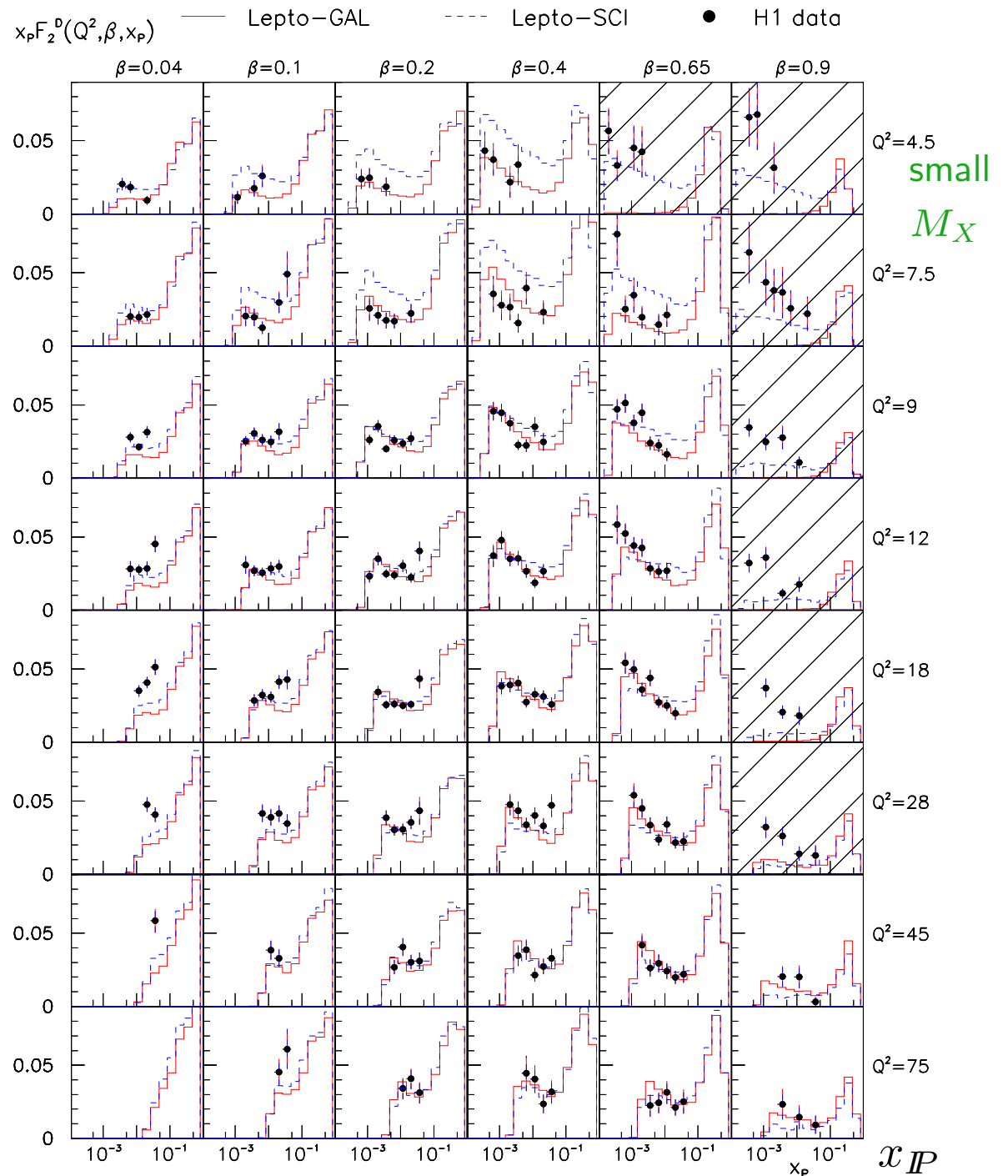

Single diffractive jets, W , Z , $b\bar{b}$, J/ψ at the Tevatron

$$R_{\text{hard}} = \frac{1}{\sigma_{\text{hard}}^{\text{tot}}} \int_{x_{F\text{min}}}^1 dx_F \frac{d\sigma_{\text{hard}}}{dx_F}$$

$R_{\text{hard}}[\%]$	Exp.	observed	SCI
dijets	CDF	0.75 ± 0.10	0.7
W	CDF	1.15 ± 0.55	1.2
W	DØ	$1.08^{+0.21}_{-0.19}$	1.2
$b\bar{b}$	CDF	0.62 ± 0.25	0.7
Z	DØ	$1.44^{+0.62}_{-0.54}$	1.0
J/ψ	CDF	1.45 ± 0.25	1.4

↑
predictions

R_{dijets} vs x of parton in \bar{p}

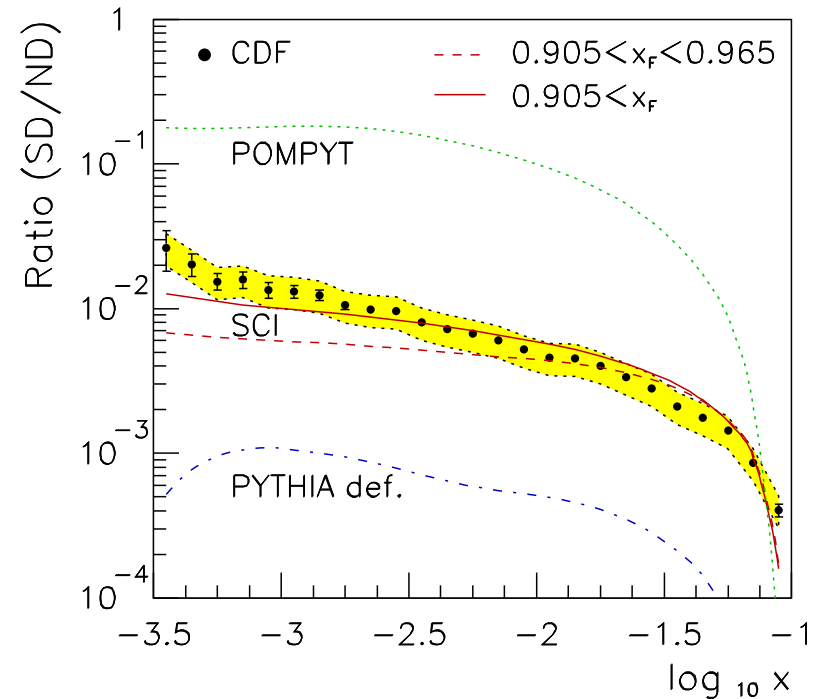

SCI \rightarrow gap & $c\bar{c}$ colour octet \rightarrow singlet $\rightarrow J/\psi$

SCI model OK, Pomeron model too high, default PYTHIA too low
 SCI also correctly describes two-gap events (Double Pomeron Exchange)

\Rightarrow Basis for predictions of diffractive Higgs production at Tevatron & LHC
 Idea: easier to reconstruct Higgs in gap-event with less hadronic activity

DPE: “Double leading Proton Events”

Double Pomeron Exchange

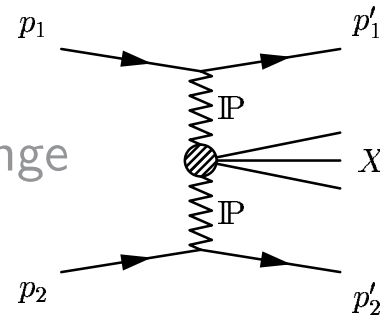

Tevatron $p\bar{p} \rightarrow$ dijets in DPE
 defined by leading \bar{p} and gap on p side

	CDF	SCI
\tilde{R}_{SD}^{DPE} [%]	0.80 ± 0.26	0.54
σ^{DPE} [nb]	43.6 ± 22.0	5–25

↑ ↑
proton gap

Strong dependence on remnant treatment
 Good ratios and cross sections

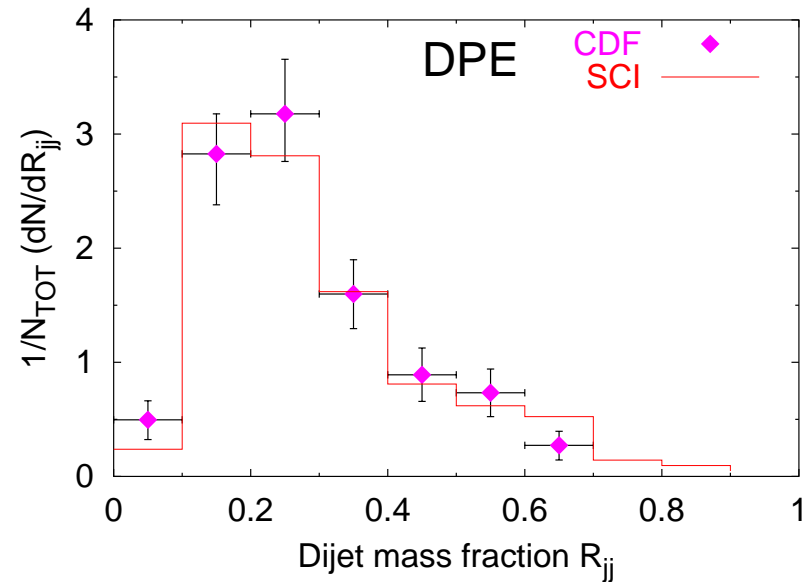

Measured dijet mass fraction
 $M_{jj}/\sqrt{\hat{s}}$ well reproduced

SCI → prompt charmonium and bottomonium

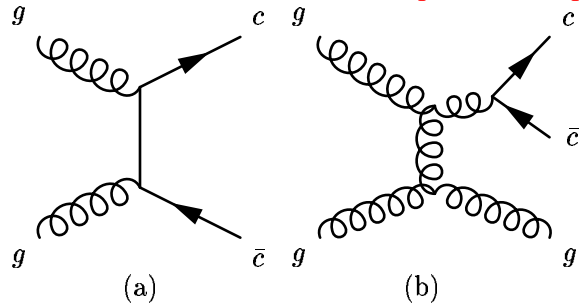

pert. QCD

↓
 $c\bar{c}$ pair

Colour octet $c\bar{c}$ turned into singlet $c\bar{c}$
 $m_{c\bar{c}} < 2m_D$ mapped on charmonium states
 with spin statistics (+ soft smearing)

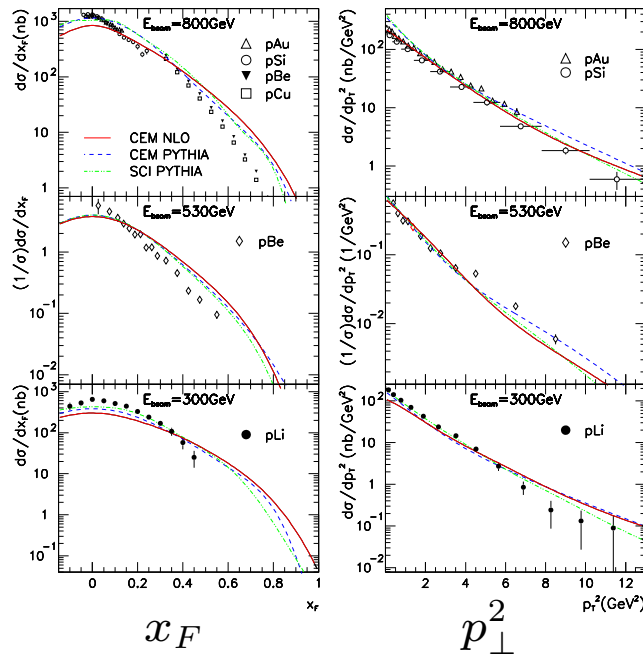

pA @
 800 GeV
 530 GeV
 300 GeV

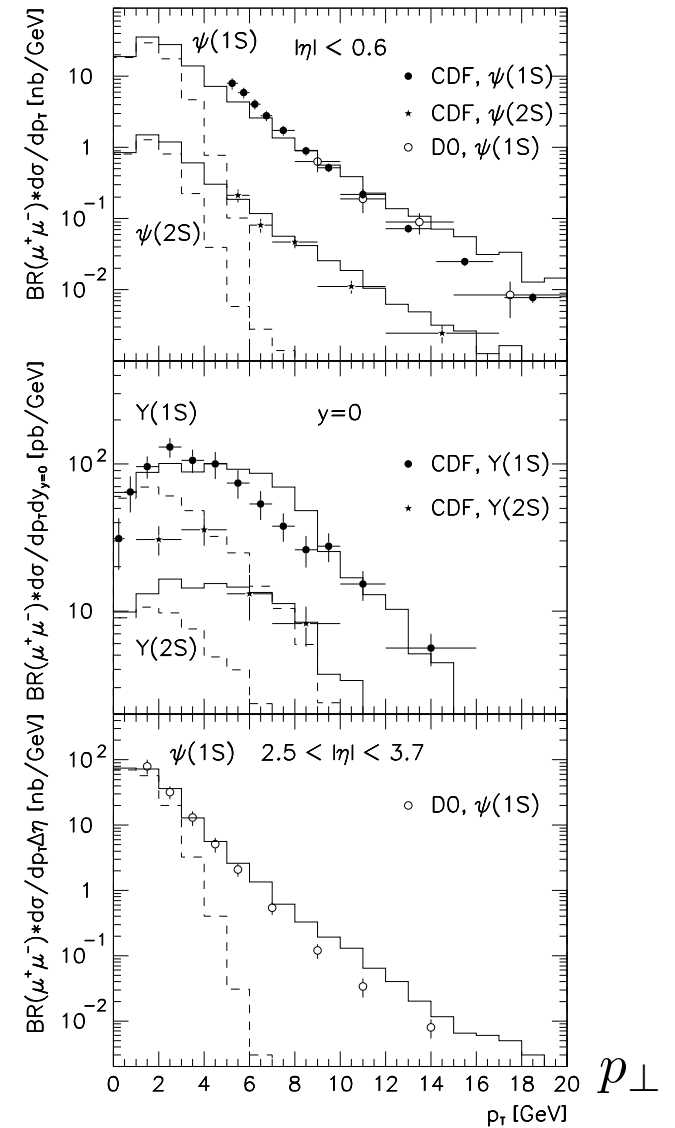

$J/\psi, \psi'$ in fixed target $\pi A, pA$ is OK

High- $p_{\perp} J/\psi, \psi', \Upsilon$ at Tevatron is OK

Soft colour interactions in B -decays

Normal decay mode $\rightarrow D$ meson

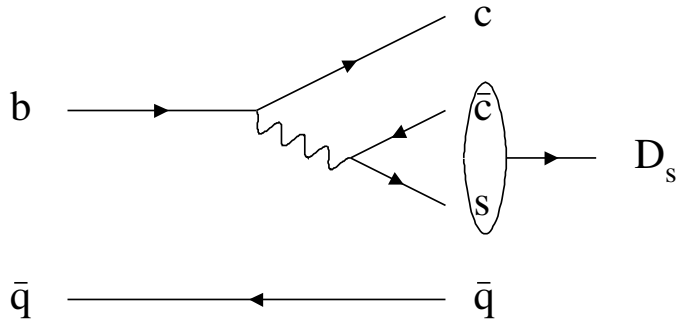

Make fit to branching ratios

$B \rightarrow D_s D$, $B \rightarrow J/\psi K_S$ (\mathcal{CP}),

$B \rightarrow D_s X$, $B \rightarrow J/\psi X$

to fix parameters

Gives good overall description:

incl. J/ψ momentum distribution

Colour-suppress decay mode, enhanced by SCI colour rearrangement

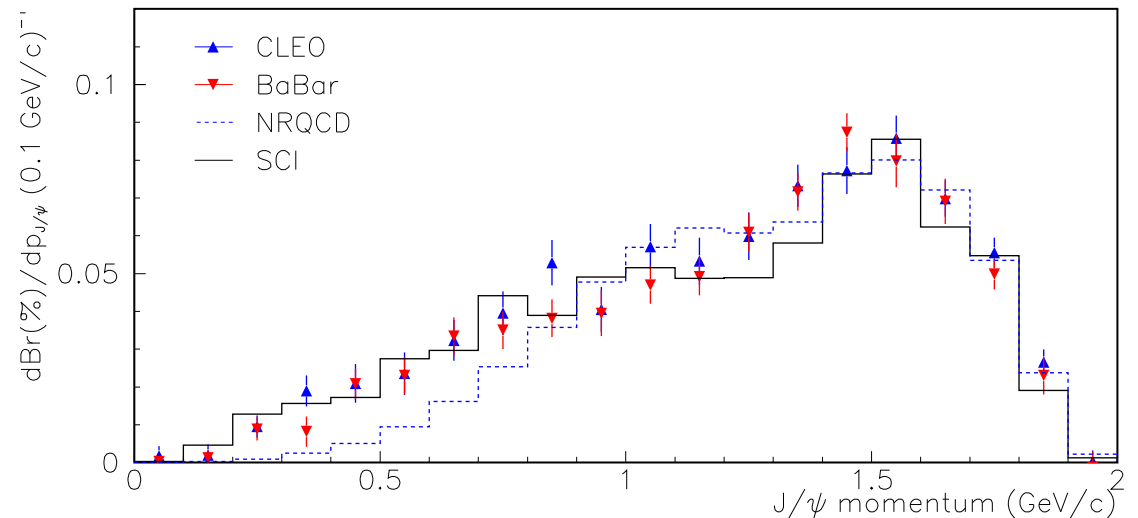
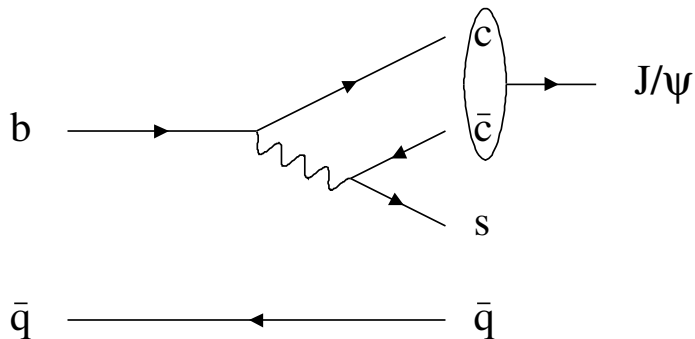

Jet quenching in quark-gluon plasma

Hadron flow in azimuth $\Delta\phi$ relative to trigger particle/jet

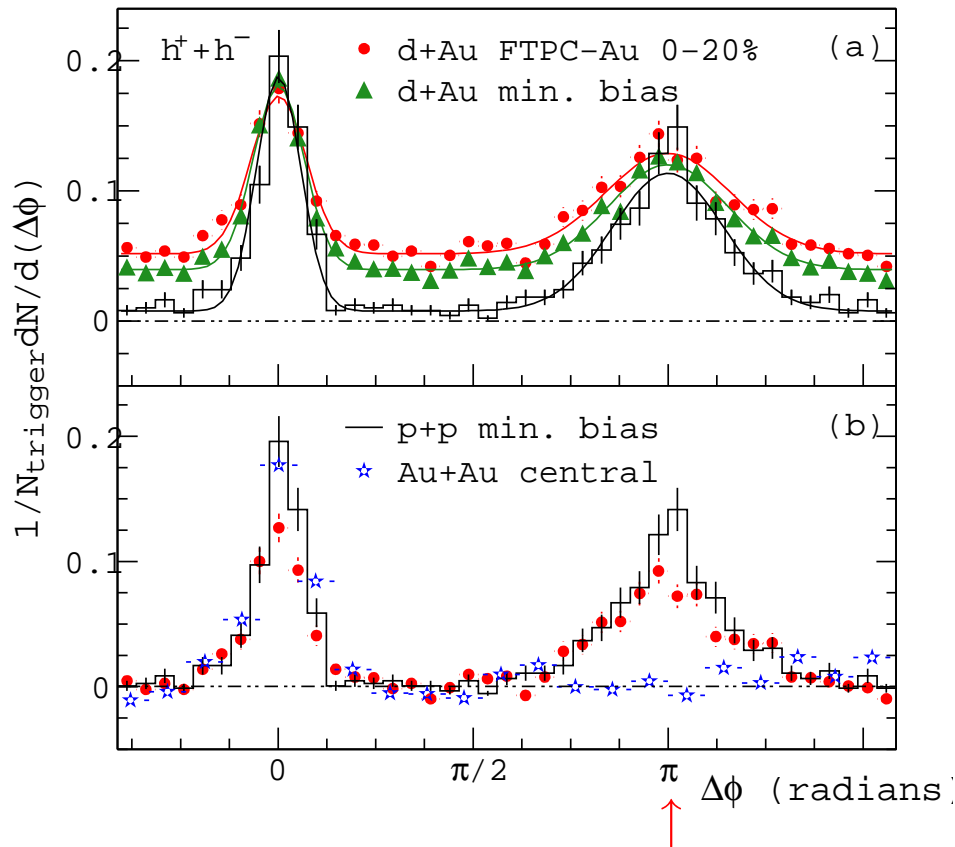

Disappearance of back-to-back jet in central gold-gold collisions

Soft colour interactions of parton with background quark-gluon plasma

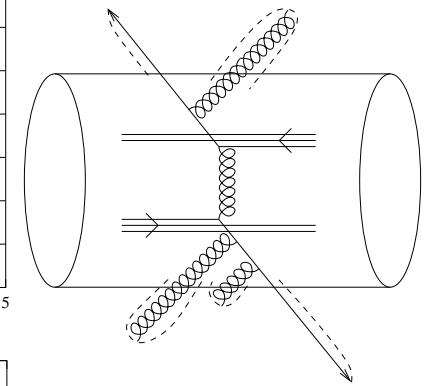
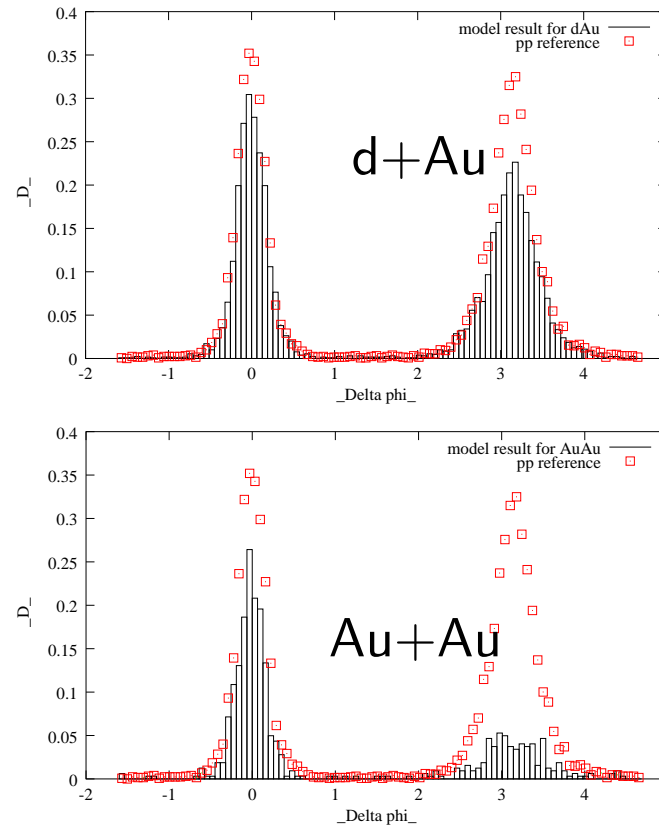

K. Zapp
Uppsala-
Heidelberg
collaboration

Reproduces effects qualitatively, but depends on model details ...

New theoretical basis for SCI model

Brodsky, Enberg, Hoyer, GI, hep-ph/0409119, PR D

Parton rescattering in QCD:

Leading twist gluon exchange between fast outgoing partons and target 'spectators'

Instantaneous 'Coulomb' gluons (light-front/Breit frame)

→ soft rescattering on 'frozen' target

Gluon attached *after* photon vertex ⇒ no pre-existing pomeron in proton

Shadowing and diffraction are rescattering effects

Colour exchange → modified colour (string) field topology

→ modified hadronic final state → gaps may arise

- gluon k_2 quickly after k_1 ⇒ can screen colour giving singlet exchange
- even/odd # gluons → pomeron/odderon exchange
- path-ordered exponential of gluon field (Wilson line)
- on-shell intermediate state ⇒ imaginary amplitude ↔ diffraction
 k_2 is 'soft' → small kinematic effect
- $F_2^D \sim g_p(x_{\mathbb{P}}) q_g(\beta)$: gluon distr. ↔ \mathbb{P} and $g \rightarrow q\bar{q}$ (or gg) gives β -dependence

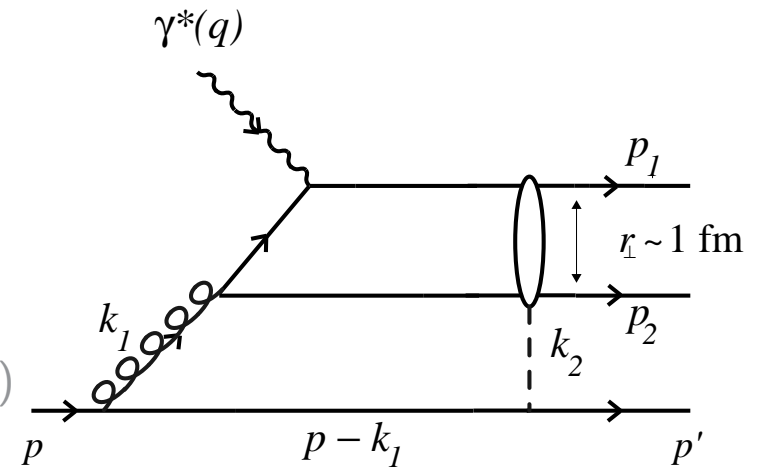

DIS on the 'Light Front'

Light Front (LF, or Light Cone LC) formalism – invariant under boosts along z
 \longrightarrow proton rest frame: interpretation depends on q_z (LF time $x^+ = t + z$)

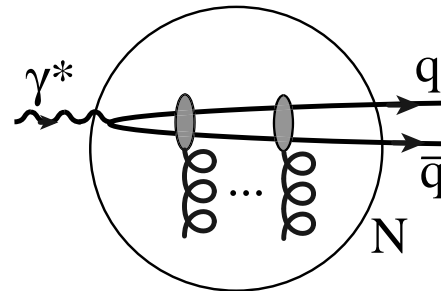
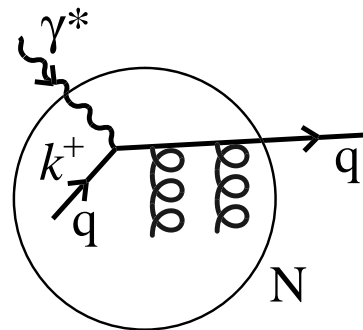

'parton model' frame:

$$q = (\nu, 0, 0, -\sqrt{\nu^2 + Q^2})$$

$$q^+ \simeq -m_p x_B, \quad q^- \simeq 2\nu$$

Photon probes target at an
instant in LF time x^+

'dipole model' frame:

$$q = (\nu, 0, 0, +\sqrt{\nu^2 + Q^2})$$

$$q^+ \simeq 2\nu, \quad q^- \simeq -m_p x_B$$

Dipole scatters on target
within finite LF time x^+

The gluons are rescatterings within coherence (loffe) length $x^- \sim 1/m_p x_B$

QCD factorisation and rescattering

QCD factorization theorem \Rightarrow separation of hard and soft

Quark parton density function (PDF) is given by

$$f_{q/N} \sim \int dx^- e^{-ix_B p^+ x^- / 2} \langle N(p) | \bar{\psi}(x^-) \gamma^+ W[x^-; 0] \psi(0) | N(p) \rangle_{x^+=0}$$

where $W[x^-; 0] = \text{P exp} \left[ig \int_0^{x^-} dw^- A_a^+(0, w^-, 0_\perp) t_a \right]$ is the **Wilson line**

Expanding the exponential we have

$$W[x^-; 0] \sim 1 + g \int \frac{dk_1^+}{2\pi} \frac{\tilde{A}^+(k_1^+)}{k_1^+ - i\varepsilon} + g^2 \int \frac{dk_1^+ dk_2^+}{(2\pi)^2} \frac{\tilde{A}^+(k_1^+) \tilde{A}^+(k_2^+)}{(k_1^+ + k_2^+ - i\varepsilon)(k_2^+ - i\varepsilon)} + \dots$$

corresponding to the diagrams

$$\times \xrightarrow{p_1} + \times \xrightarrow{p_1 - k_1} \xrightarrow{p_1} \quad + \quad \times \xrightarrow{p_1 - k_1 - k_2} \xrightarrow{p_1 - k_2} \xrightarrow{p_1} + \dots$$

for **rescattering of the struck quark via longitudinal (A^+) instantaneous (in x^+) gluon exchange**. No A^\perp within Ioffe coherence length $x^- \sim 1/m_p x_B$

Brodsky, Hoyer, Marchal, Peigné, Sannino, Phys. Rev. D65 (2002) 114025

QCD rescattering and factorisation in DIS

The Wilson line means that DIS looks something like this:

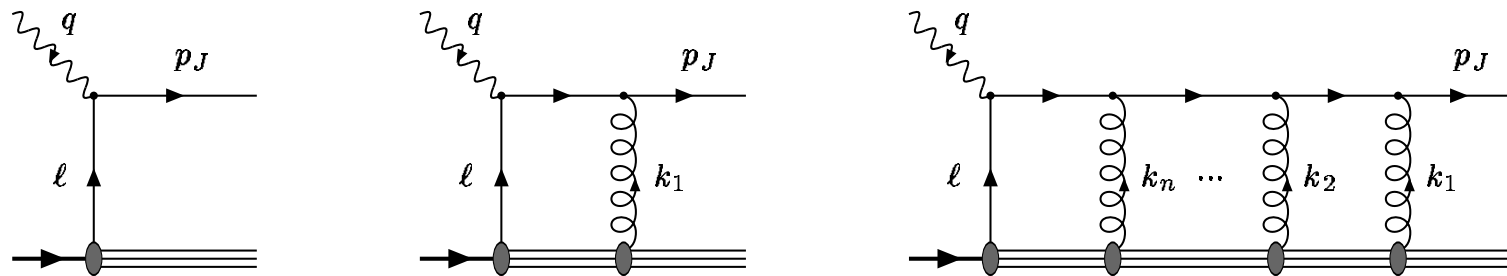

- Rescattering compatible with factorization theorems *by construction*
Wilson line part of definition of PDF \Rightarrow rescattering part of PDF
- Experimentally measured PDF's *include* rescattering
- Diffractive PDF's included in inclusive PDF's
- Rescattering can give on-shell intermediate states and *imaginary amplitudes* \Rightarrow diffraction

Mechanism for diffraction in DIS

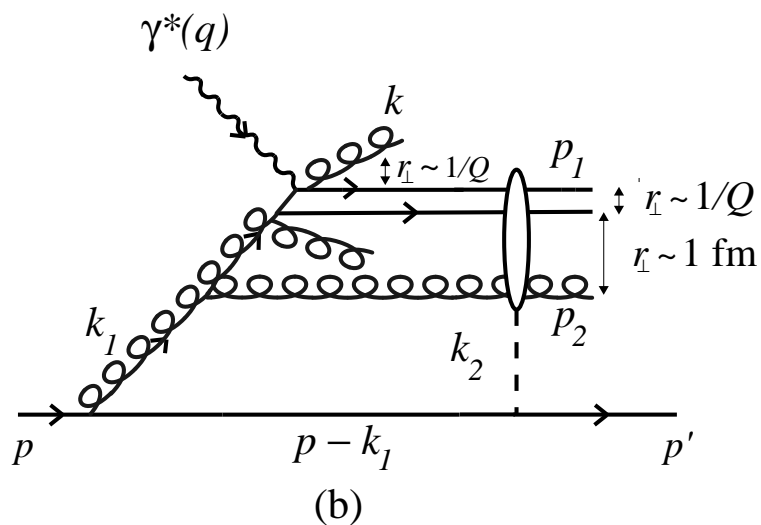
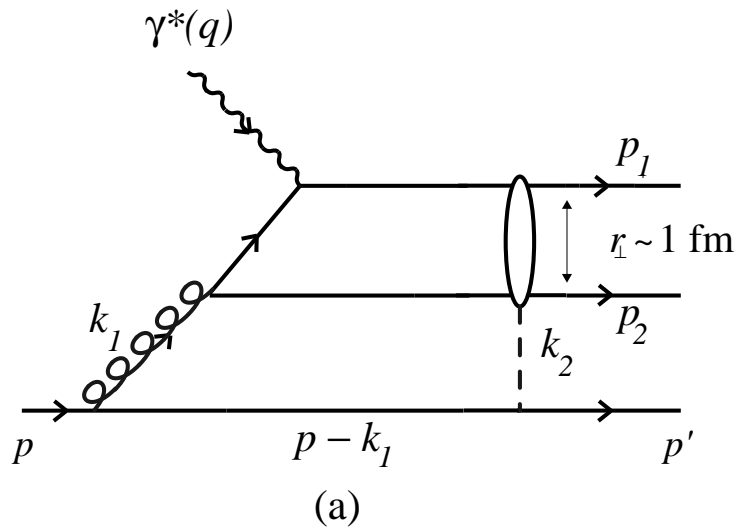

The 'pomeron remnant' is soft
— first splitting is in the sea

1. A soft gluon with $k_1^+ / p^+ \sim x_{\mathbb{P}}$ splits into large $q\bar{q}$ pair
 $g \rightarrow q\bar{q} \Rightarrow f(\beta) \sim \beta^2 + (1 - \beta)^2$
2. The γ^* scatters and a large size $q - \bar{q}$ 'dipole' is formed
3. **Instantaneous gluon exchanges** may make dipole color singlet

- At large M_X , $q\bar{q} - g$ dipole dominates
 - soft gluon splits into gg pair
 $g \rightarrow gg \Rightarrow f(\beta) \sim 1/\beta$
 - compact $q\bar{q}$ pair not resolved

- **Higher order emissions do not destroy the rapidity gap!**

$k_\perp \gg p_{2\perp}$ and $k^+ \lesssim p_2^+$
 \Rightarrow rapidity of k larger than that of p_2

Radiation is close to γ^* vertex and is not resolved by the rescattering

Consequences for diffractive DIS

- Same hard sub-process in diffractive and non-diffractive events
- Same Q^2 dependence in diffractive and inclusive DIS
- Same energy (W or x_B) dependence in diffractive and inclusive DIS

$\Rightarrow \sigma_{\text{diff}}/\sigma_{\text{tot}}$ independent of x_B and Q^2 , as observed in data

- Amplitudes from rescattering dominantly imaginary, as expected for diffraction
- Rescattering gluons have small momenta $\Rightarrow \beta$ dependence of diffractive PDF's from underlying (non-perturbative) $g \rightarrow q\bar{q}$ and $g \rightarrow gg$ processes

- Effective \mathbb{P} flux:
$$f_{\mathbb{P}/p}(x_{\mathbb{P}}) \sim g(x_{\mathbb{P}}, Q_0^2)$$

Effective \mathbb{P} structure function:
$$f_{q/\mathbb{P}}(\beta, Q_0^2) \sim \beta^2 + (1 - \beta)^2$$

$$f_{g/\mathbb{P}}(\beta, Q_0^2) \sim 1/\beta$$

Colour coherence and SCI

Resolve partons \Leftrightarrow short gluon wave length

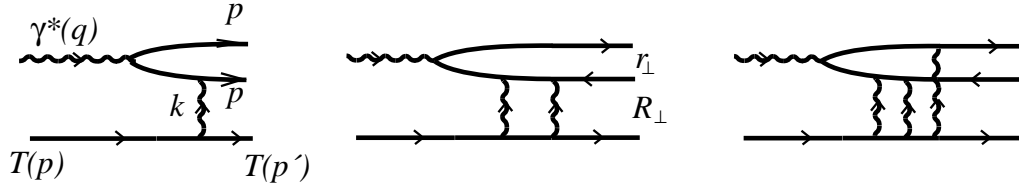

Amplitudes for 1, 2, ... n-gluon exchange

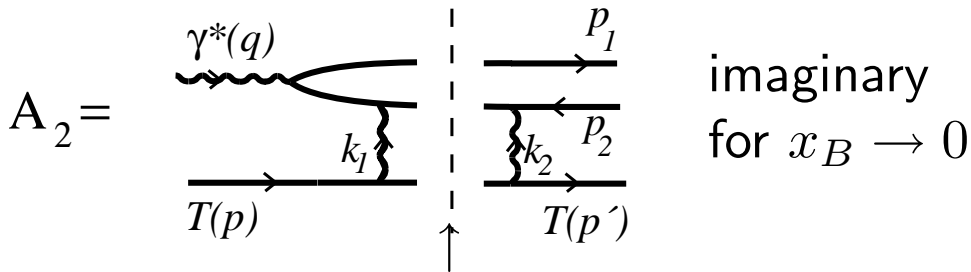

\Rightarrow on-shell intermediate state

\Rightarrow factorized amplitudes:

$$A_1 = eg^2 \mathcal{C} V(m, x_B, \mathbf{r}_\perp) W(\mathbf{r}_\perp, \mathbf{R}_\perp)$$

$$A_2 = \frac{-ieg^4}{2} \mathcal{C} V(m, x_B, \mathbf{r}_\perp) W^2(\mathbf{r}_\perp, \mathbf{R}_\perp)$$

$$= \frac{-ig^2}{2!} W A_1$$

\vdots

$$A_n = \frac{(-ig^2)^{n-1}}{n!} W^{n-1} A_1$$

\mathcal{C} = kinematics, V = photon wave function

Fourier transform to coordinate space

\mathbf{r}_\perp $q\bar{q}$ colour dipole size

\mathbf{R}_\perp conjugate coord. to \mathbf{k}_\perp

frozen during scattering process

$$W(\mathbf{r}_\perp, \mathbf{R}_\perp) = \frac{1}{2\pi} \log \left(\frac{|\mathbf{R}_\perp + \mathbf{r}_\perp|}{|\mathbf{R}_\perp|} \right)$$

\Rightarrow gluon coupling to dipole decreases

for $|\mathbf{r}_\perp|/|\mathbf{R}_\perp| \lesssim 1$, i.e. $|\mathbf{k}_\perp| \lesssim 1/|\mathbf{r}_\perp|$

\Rightarrow SCI colour exchange probability

should vary dynamically with W^2

Softer (k_\perp) gluon \rightarrow less interaction with small colour dipole (not resolved)

\updownarrow

colour coherence

Summary

SCI model OK with data:

- gap events in DIS
- leading protons/neutrons in DIS
- diffractive jets, W , Z , $b\bar{b}$, J/ψ at Tevatron
- high- p_{\perp} J/ψ , ψ' , Υ at Tevatron
- J/ψ , ψ' in fixed target πA and pA

Not bad for simple (one-parameter) model !

\exists alternative/related models

Parton rescattering theory in QCD:

- Hard sub-process universal
not affected by soft interaction
- PDF \sim LF wave fcn \otimes soft rescattering
- Rescattering via soft gluons,
instantaneous in LF time
May shield colour \rightarrow rapidity gap
- Soft rescattering does not resolve
hard emissions
- Different colour environments
(particles/collisions)
 \Rightarrow diffraction/gaps process dependent

Outlook

- Non-perturbative QCD major unsolved problem
 - QCD rescattering theory
 - theory for diffraction/gaps
 - basis for successful SCI model
 - implies developments of SCI model
e.g. colour coherence from dynamical gluon exchange probability
 - Parton interaction with colour background field
 - 'old' idea with new aspects
 - parton traversing quark-gluon plasma → jet quenching
 - New ideas, new collaborations . . . lots of fun . . .
- ⇒ Better understanding of non-perturbative QCD

Additional material . . .

Related models

- **Colour evaporation model** (Halzen *et al.*)
many exchanges \rightarrow random colour
Diffractive DIS (Buchmüller *et al.*)
 $\gamma g \rightarrow q\bar{q}$ octet \rightarrow singlet $q\bar{q}$ (prob=1/9)
which decouples from remnant \rightarrow gap event
- **Interactions with background colour field** (Nachtmann *et al.*)
e.g. quark traversing colour field gives 'synchrotron' radiation
of soft γ 's
- **Semiclassical model** (Buchmüller, Hebecker *et al.*)
Diffractive DIS: $\gamma \rightarrow q\bar{q}$ which traverses proton colour field
interaction \sim Wilson loop averaging over colour field
- **String reconnection models** (Lund group)
e.g. applied to $e^+e^- \rightarrow WW \rightarrow q\bar{q} q\bar{q}$
gives shift in W mass determination

SCI \rightarrow diffractive Higgs at Tevatron/LHC

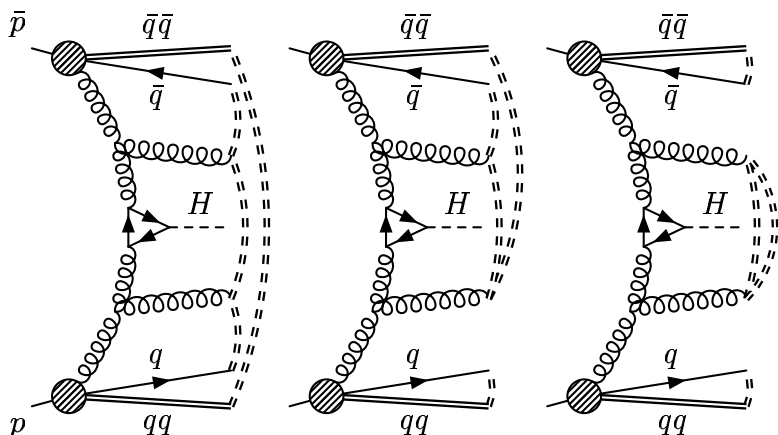

Idea: diffractive events cleaner
 \rightarrow easier Higgs reconstruction
 \rightarrow Higgs discovery channel ?

$m_H = 115 \text{ GeV}$		Tevatron $\mathcal{L} = 20 \text{ fb}^{-1}$	LHC $\mathcal{L} = 30 \text{ fb}^{-1}$
	$\sigma [\text{fb}]$ Higgs-total	600	27000
SD	$\sigma [\text{fb}]$ leading-p	1.2	190
	$\sigma [\text{fb}]$ gap	2.4	27
	$\#$ H + leading-p	24	5700
	$\hookrightarrow \#$ H $\rightarrow \gamma\gamma$	0.05	13
DPE	$\sigma [\text{fb}]$ leading-p's	$1.2 \cdot 10^{-4}$	0.19
	$\sigma [\text{fb}]$ gaps	$2.4 \cdot 10^{-3}$	$2.7 \cdot 10^{-4}$
	$\#$ H + leading-p's	0.0024	6

large m_H + large x_F proton \rightarrow kinematical conflict \rightarrow reduced cross-section

Tevatron: only few SD Higgs \Rightarrow $H \rightarrow b\bar{b}$ background/reconstruction problems

LHC: Higgs observable in SD (also $H \rightarrow \gamma\gamma$) and DPE

but not so clean since particles in 'gap' region \rightarrow 'pots' better

Diffractive $H \rightarrow \gamma\gamma$ and prompt $\gamma\gamma$

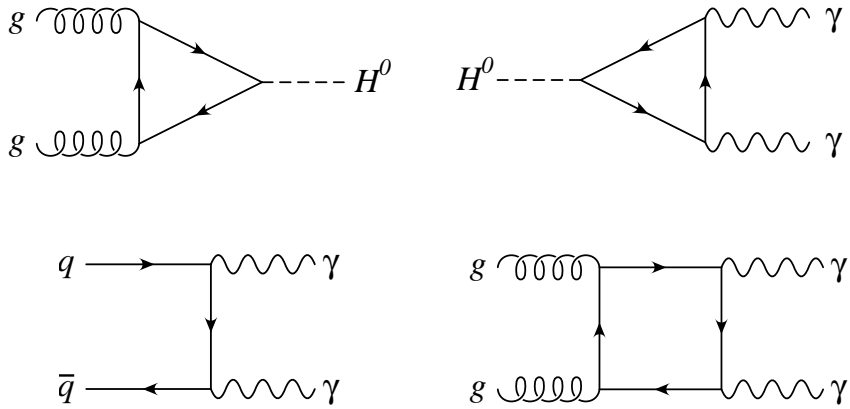

Prompt $\gamma\gamma$ irreducible background
 $> \sigma(H) \cdot \text{BR}(H \rightarrow \gamma\gamma)$

$\gamma\gamma$ tests gg fusion via quark loop
 \Rightarrow safer Higgs prediction

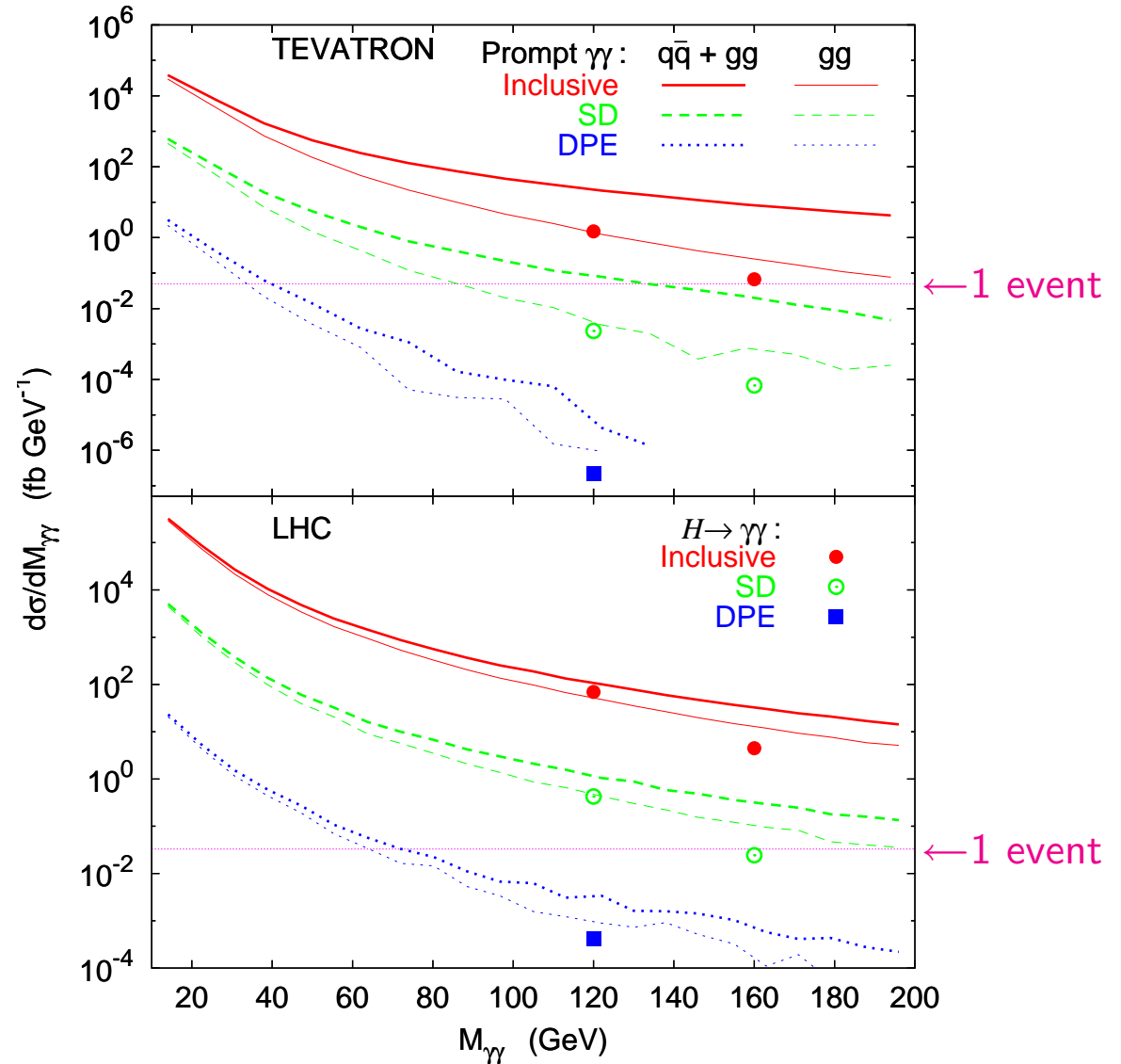

Soft and hard rapidity gaps

Soft/hard gap \Leftrightarrow small/large momentum transfer across gap
 non-perturbative/perturbative QCD description

Hard gap between jets:

- observed at Tevatron
- understood/described by exchange of colour singlet BFKL gluon ladder with non-leading corrections

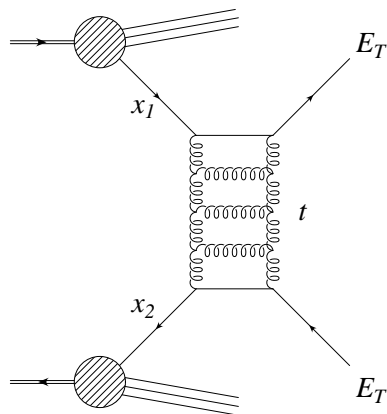

Enberg, GI, Motyka, PL B524 (2002) 273

Soft gap \leftrightarrow leading proton:

- 'soft-soft' \Rightarrow hadron basis \rightarrow Regge

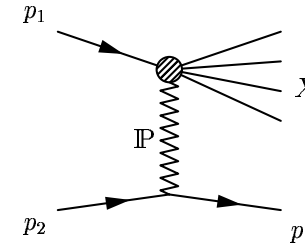

- 'hard-soft' \leftrightarrow hard int'n – gap – proton
 DIS/jets/W + gap
 \rightarrow pQCD partons + hadronisation
 \Rightarrow mixed basis: parton & hadron

Models:

- Regge \rightarrow pomeron structure works, but problematic
- Soft Colour Interactions . . .

Gap between jets \rightarrow hard QCD exchange

Rapidity gap **between** a pair of jets

- $\rightarrow |t|$ across gap is large
- \rightarrow different from “normal” diffraction

Elastic parton-parton scattering by hard colour singlet exchange (hard pomeron)

High energy limit $s/|t| \gg 1 \Rightarrow$ amplitude dominated by terms $\sim [\alpha_s \ln(s/|t|)]^n$

BFKL equation resums these terms, including

- virtual corrections
- reggeization of the exchanged gluons

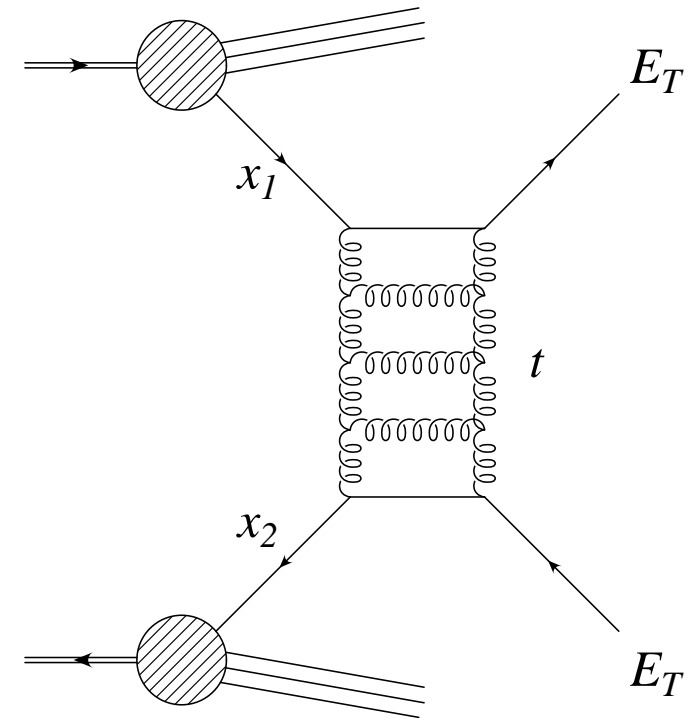

Numerical solution of BFKL eqn. with non-leading corrections

consistency constraint & running coupling \leftrightarrow

Comparison to data – gap survival

This subprocess implemented in PYTHIA → account for gap survival depending on HO parton emissions, multiple scatterings, hadronization

SCI destroys gaps by re-arranging strings across gaps

- Good agreement with DØ data
 - E_T and $\Delta\eta$ dependences OK
 - absolute normalisation OK
 - i.e.* correct gap survival probability
 - too large gap survival prob. without SCI
- Previous asymptotic result (Mueller-Tang) ⇒ wrong E_T -dependence

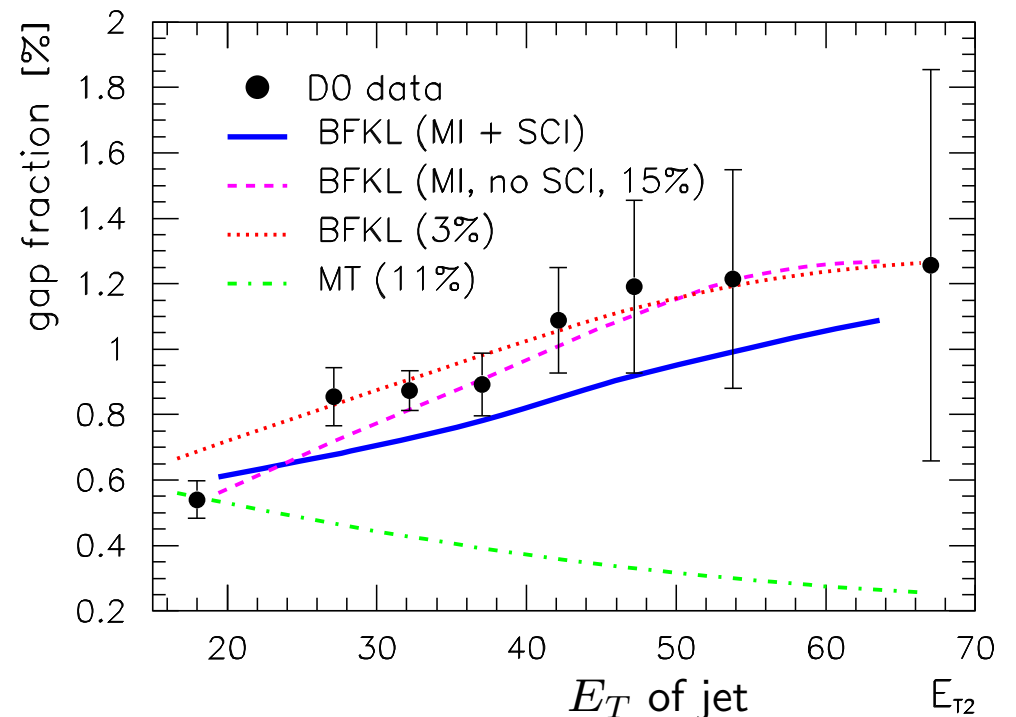

First clear evidence of BFKL dynamics ⇒ better understanding of data and QCD